

# DECK ACCESSORIES

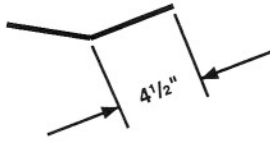

**RIDGE OR VALLEY PLATE (20 GA.)**  
10'-0" LENGTHS  
GALVANIZED ONLY

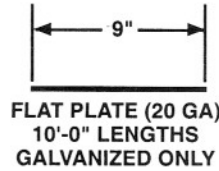

**FLAT PLATE (20 GA)**  
10'-0" LENGTHS  
GALVANIZED ONLY

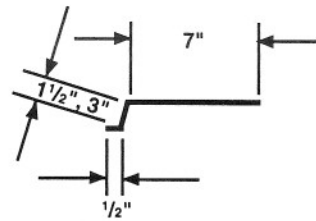

**FILLER SHEET (20 GA.)**  
10'-0" LENGTHS  
GALVANIZED ONLY



**RUBBER CLOSURES**  
TOP & UNDERSIDE

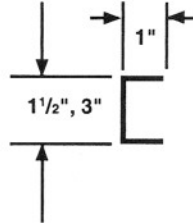

**INSIDE OR OUTSIDE CLOSURE (20 GA.)**  
10'-0" LENGTHS  
GALVANIZED ONLY

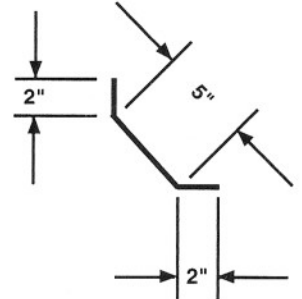

**CANT STRIP (20 GA)**  
10'-0" LENGTHS  
GALVANIZED ONLY

**Screws:**

- Sidelap - #10 - 16 x 3/4" (Type 2) Standard
- #12 - 14 x 3/4" (Type 3) Optional
- Support - #12 - 24 x 1 1/4" (Type 5)
- Increments of 1000 pieces

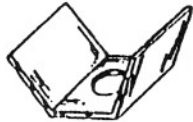

**WELDING WASHER**  
16 GAGE  
3/8" = HOLE

**Sump Pans (Flat/Recessed)**  
Holes to be cut in the field by others

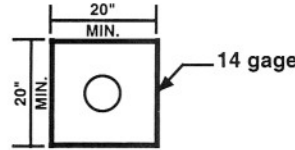

**Flat Sump Pan**  
20" x 20" x 14 GAGE Standard

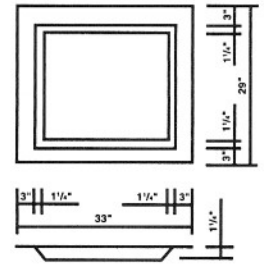

**Recessed Sump Pan**  
29" x 33" x 14 GAGE Standard

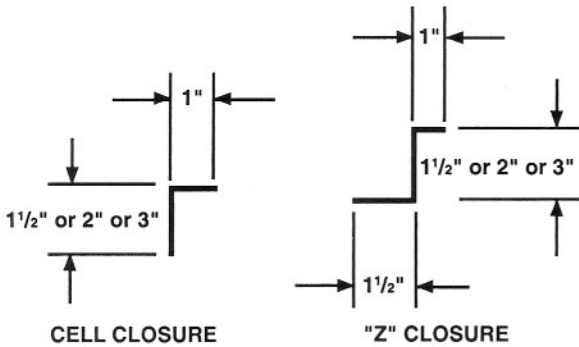

10'-0" LENGTHS  
GALVANIZED ONLY (20 GA.)

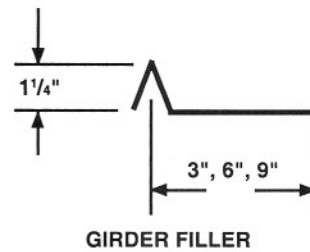

**GIRDER FILLER**

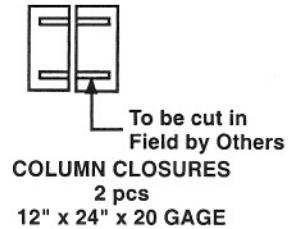

**COLUMN CLOSURES**  
2 pcs  
12" x 24" x 20 GAGE

**ROLLED IN  
HANGER TAB**

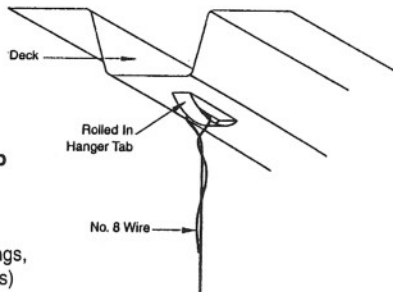

**Integral Hanger Tab**  
Allowable load 100 lb.  
(Types 20, 18, & 16)  
(Not to be used for  
suspended plaster ceilings,  
walkways, and/or utilities)

**Recommended Girder  
Filler Thickness**

L CLEAR SPAN	METAL GAGE (TYPE)
0" to 5"	20
5"+ to 7-1/2"	16
7-1/2"+ to 9"	14

\* Not to exceed 12". Above gages are based on flat material with no strength increase due to its shape

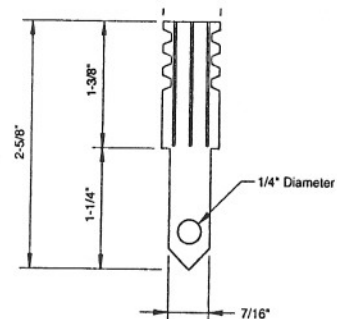

**Piercing Hanger Tab**  
Allowable Load 250 lb. when imbedded in concrete.